

Recumbent Trike Assembly Instruction

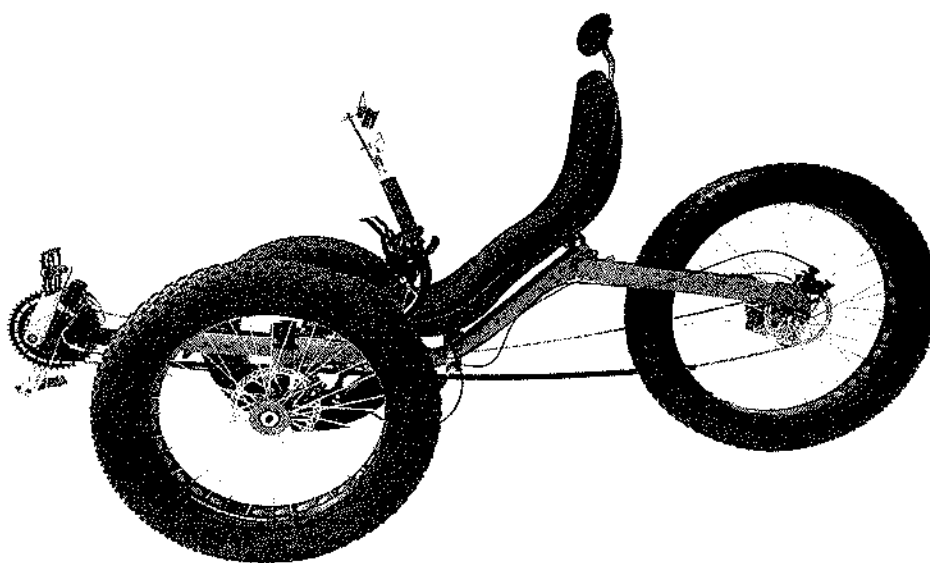

Check all the parts

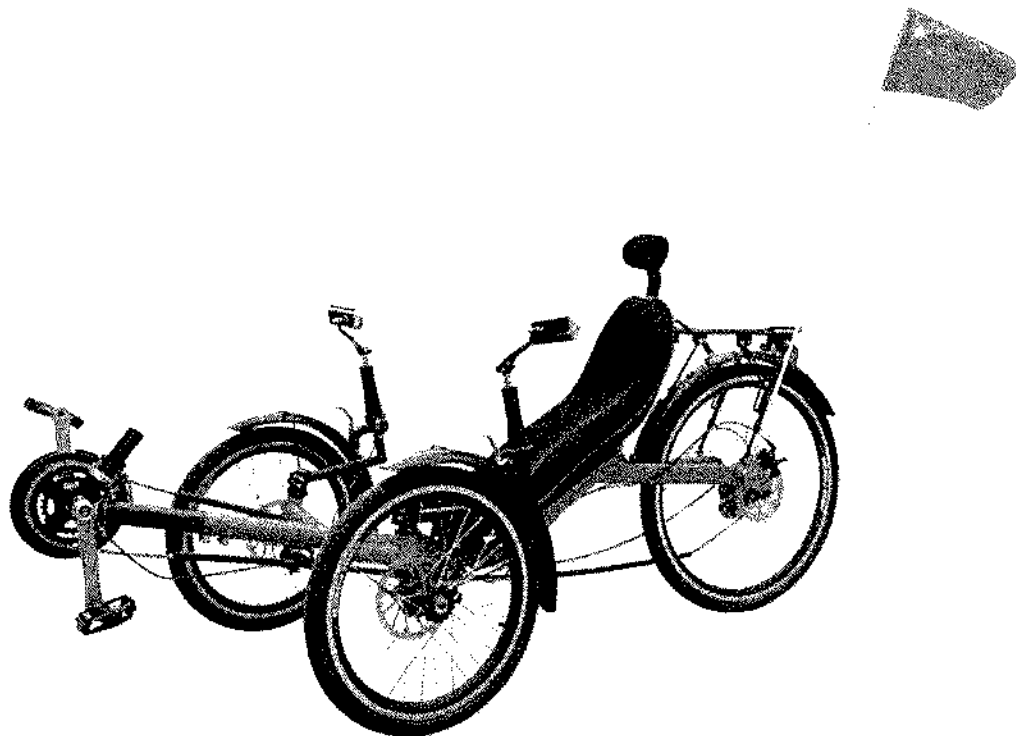
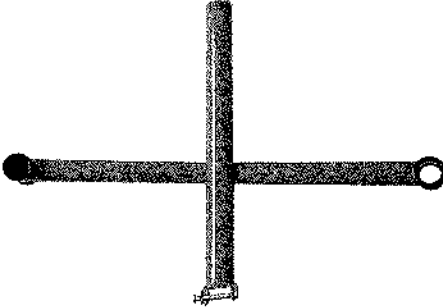

Main frame (cross frame)

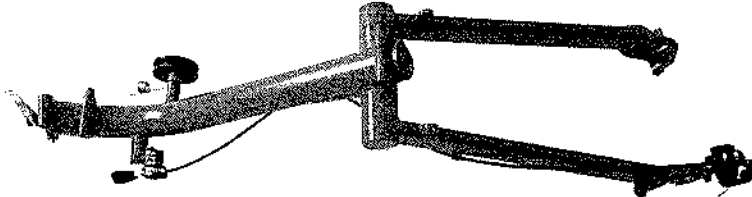

Main frame (rear fork)

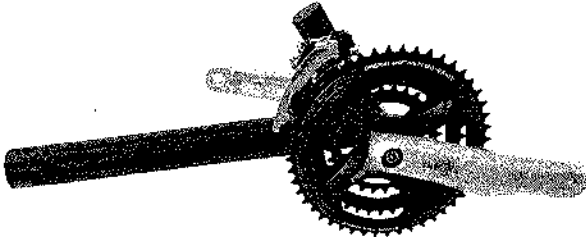

Front boom with crankset

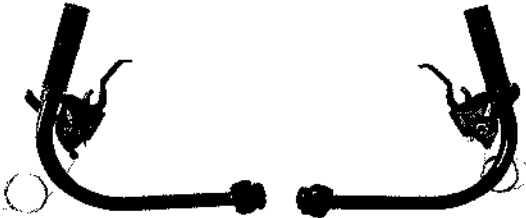

Handlebars

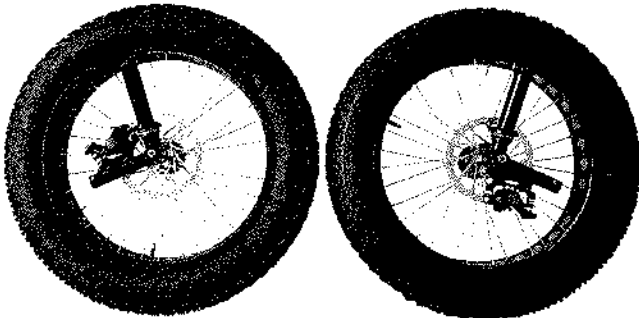

Front wheels with steering shaft

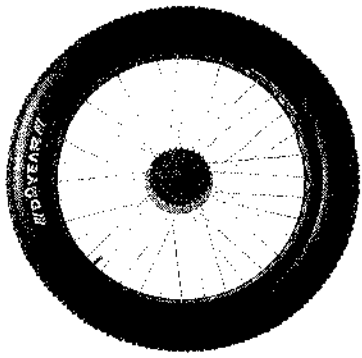

Rear wheel



Steering rod



Brake and derailleur cables



Chain tubes



Seat

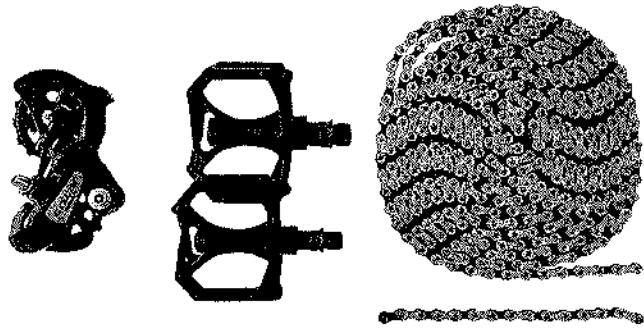

Rear derailleur, pedals, chain

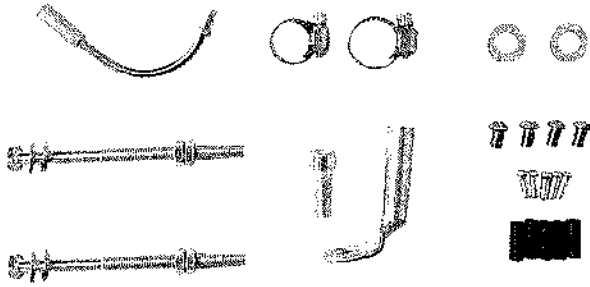

Bolts and screws

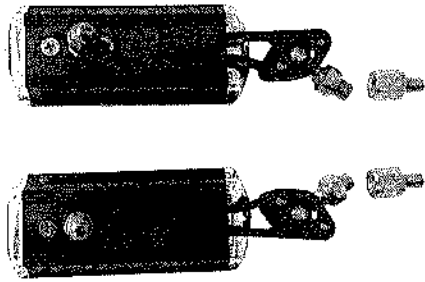

Mirrors

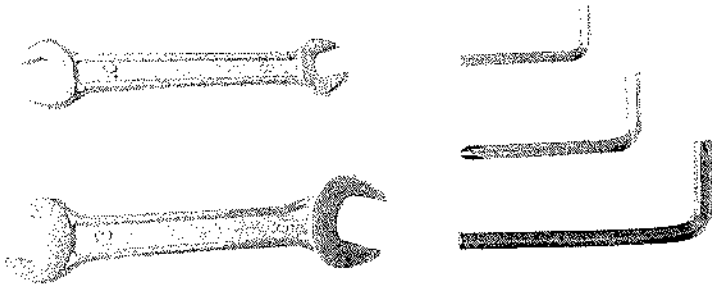

Tools

1. Assemble the main frame

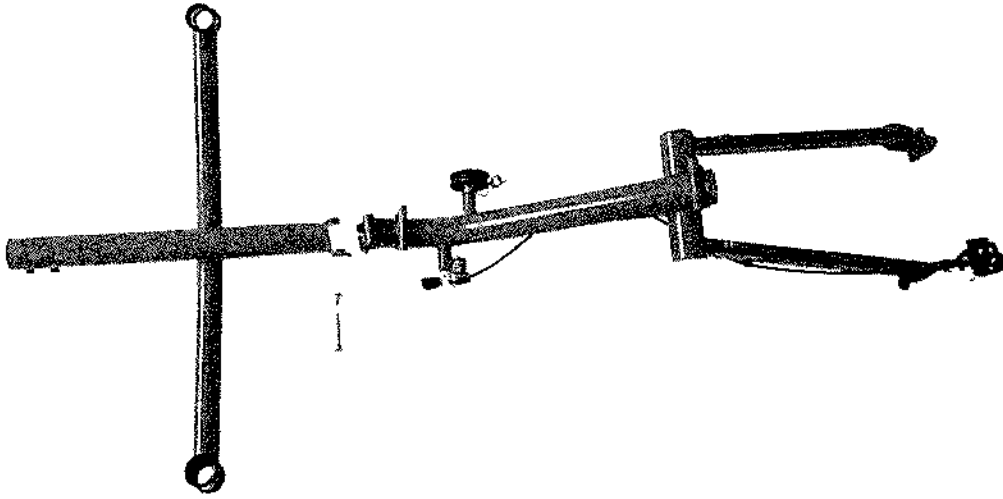

- a. Connect the cross frame and rear fork by the bolts
- b. Tighten the quick released screw

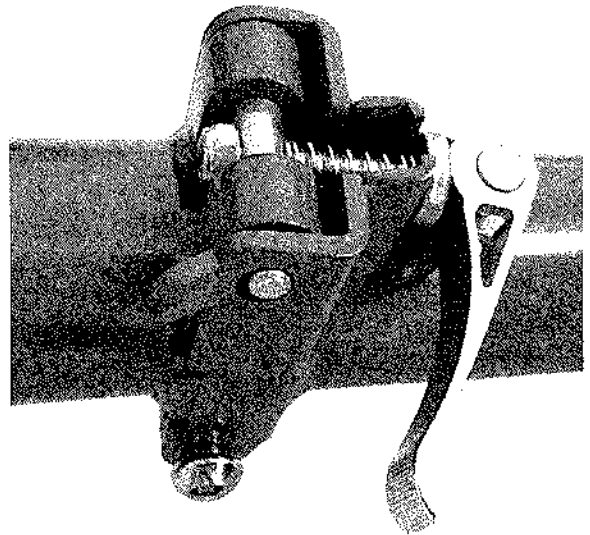
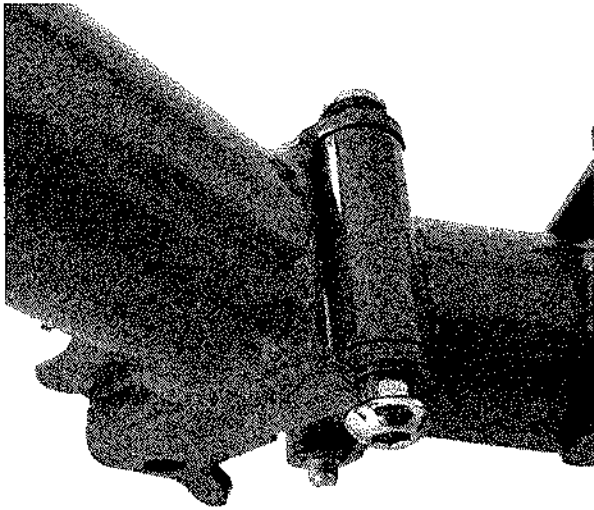

- c. Finish assembly the main frame

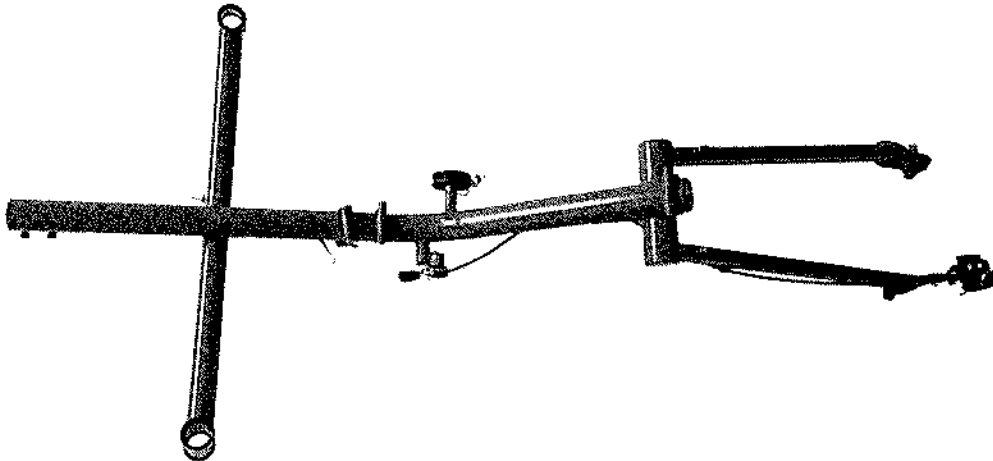

2. Assemble the rear wheel

a. Put the rear fork and rear wheel in right position

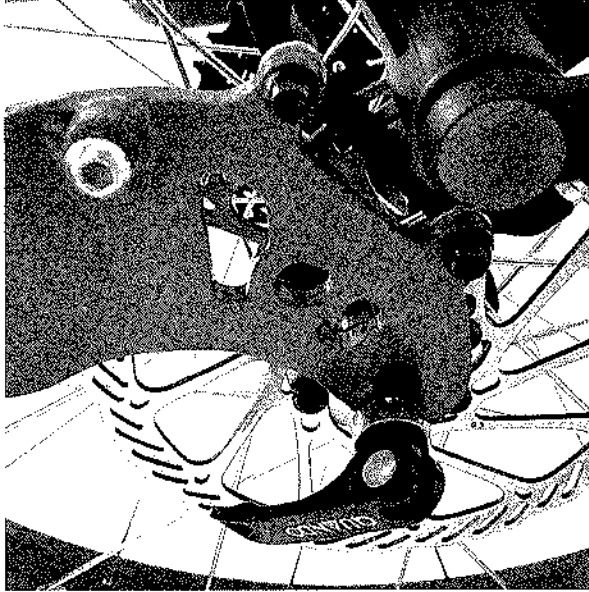

b. Tighten the quick released screw

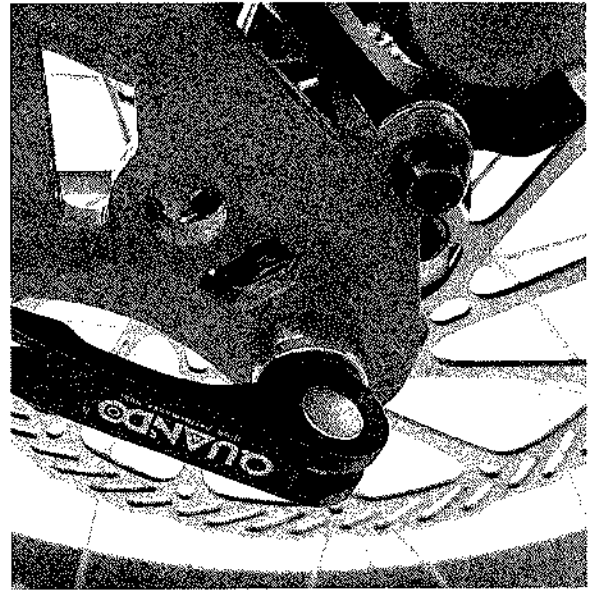

3. Assemble the front wheels

a. Take off the head sets from the steering shaft

b. Insert the steering shaft into the cross frame.

(Please pay attention to the position of the parts ①②③④.)

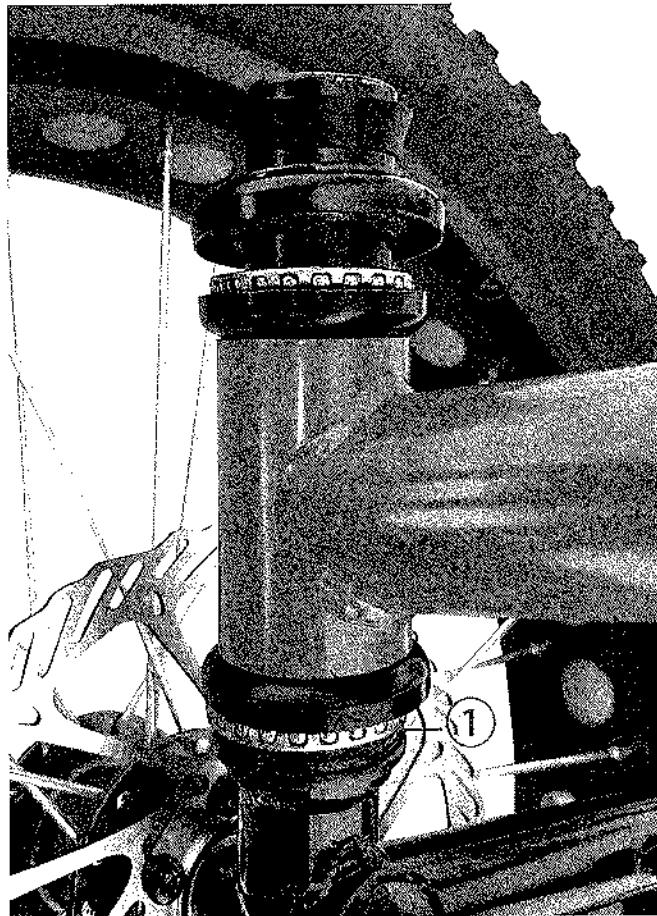

4. Assemble the steering rod

Mount the steering rod on the steering shaft
(Please do not adjust the length of the rod.)

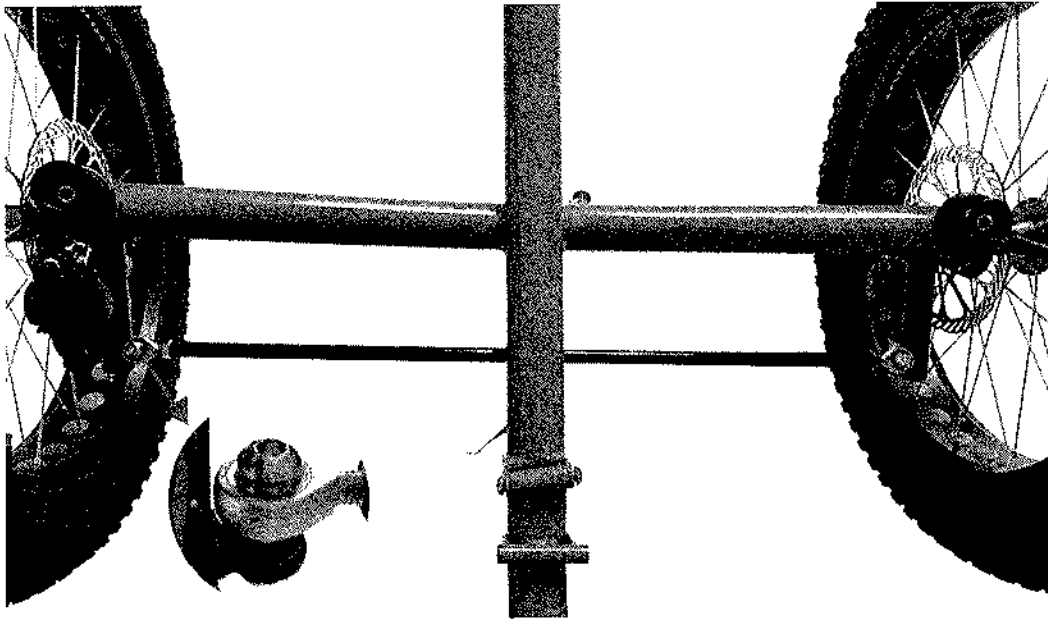

5. Assemble the handlebars

- a. Insert the handlebars into the steering shafts and tighten the screws
- b. Mount the head cover



6. Assemble the handlebars

Insert the front boom into the tube of cross frame.
(The distance in the tube should be at less 15 cm for security.)

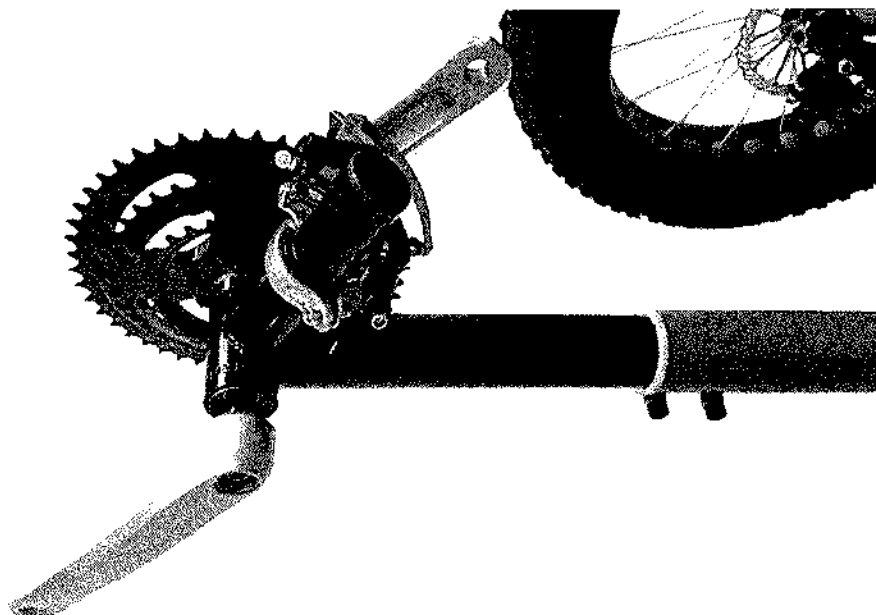

7. Assemble the rear derailleur

Assemble the rear derailleur on the rear fork

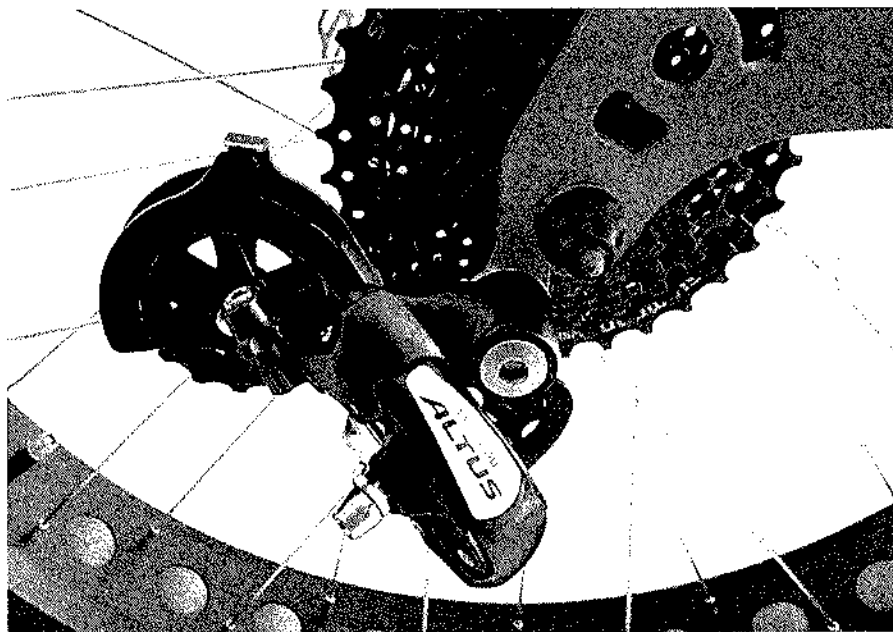

8. Assemble the chain tube

a. Insert the chain tubes into the ring

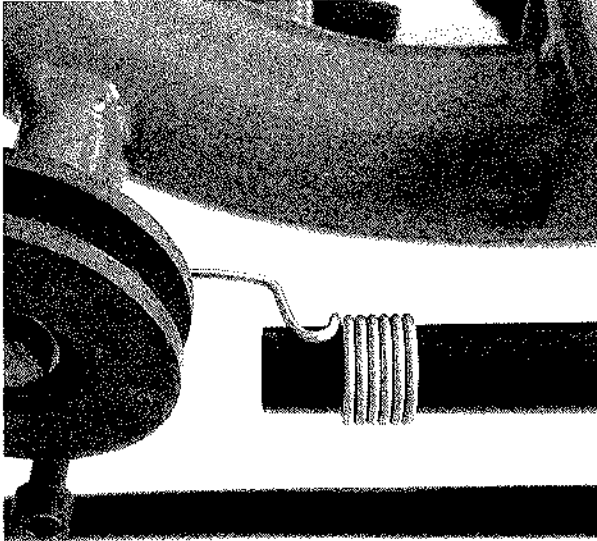

b. Fixed them by screw

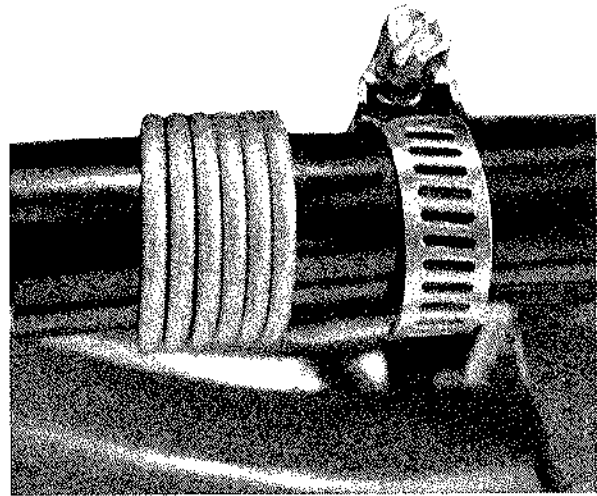

c. Finish assembly the chain tubes

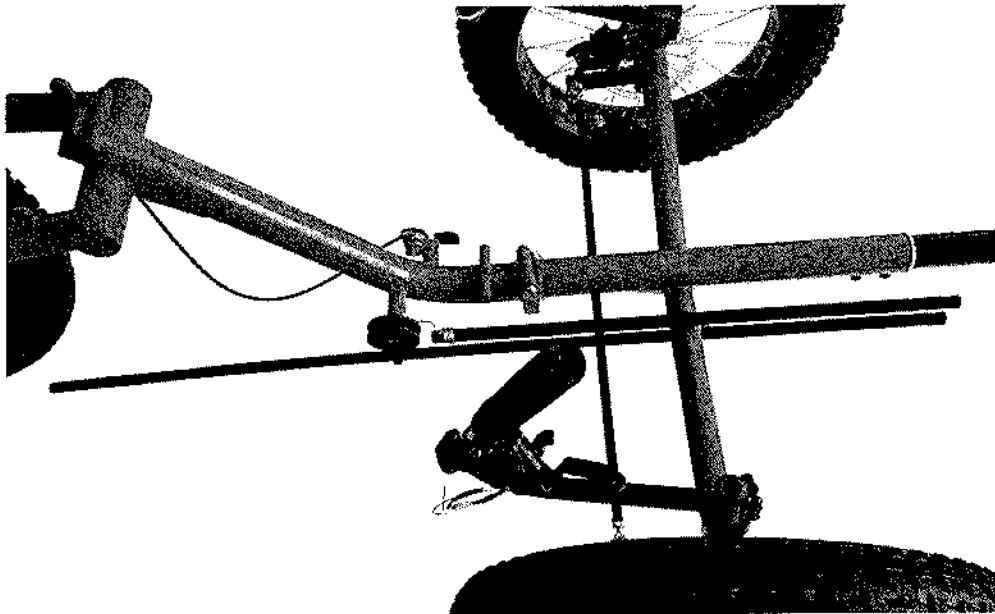

9. Assemble the chain

a. Pass the chain through the short chain tube, chain wheel, cassette, rear derailleur, long chain tube, crankset, and then connect the chain.

(Chip "L" pin through the end of the chain.)

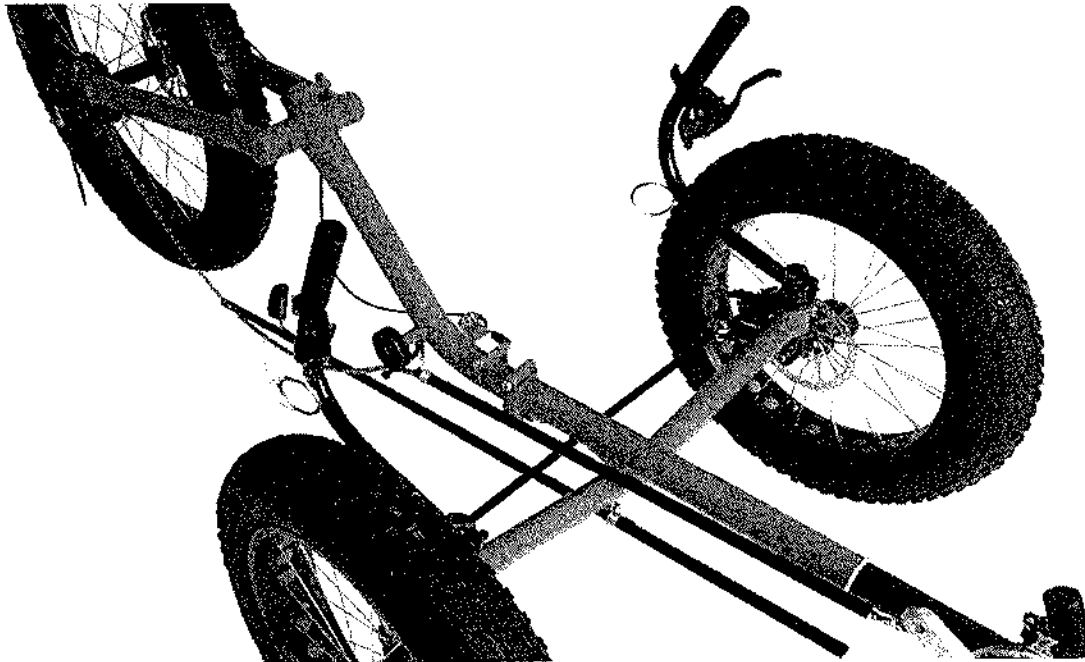
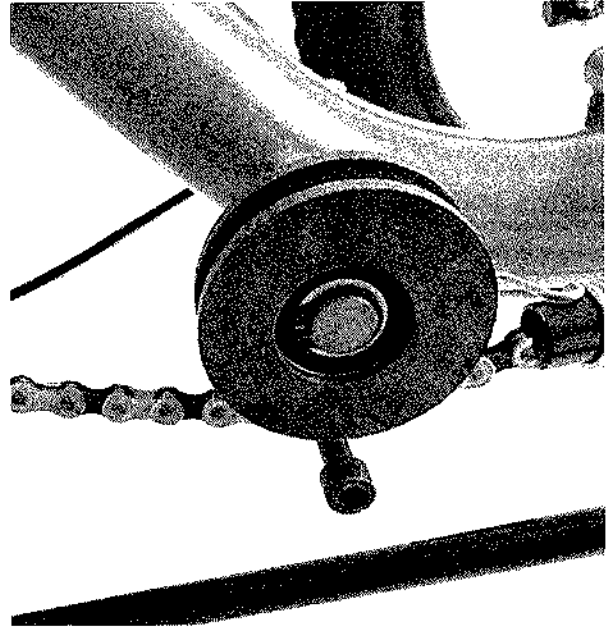
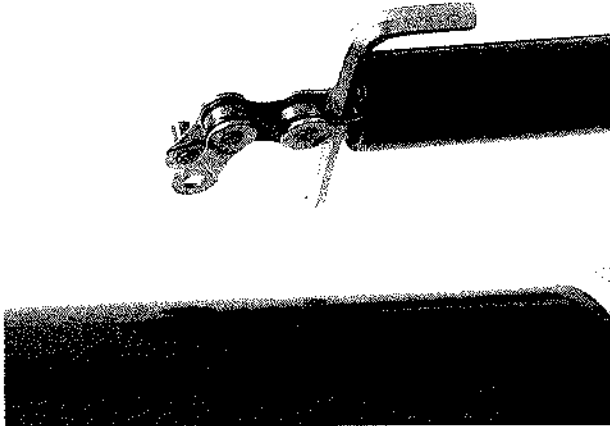

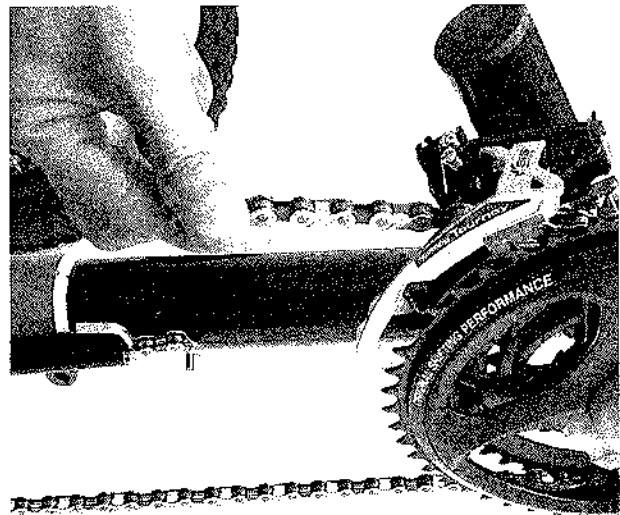
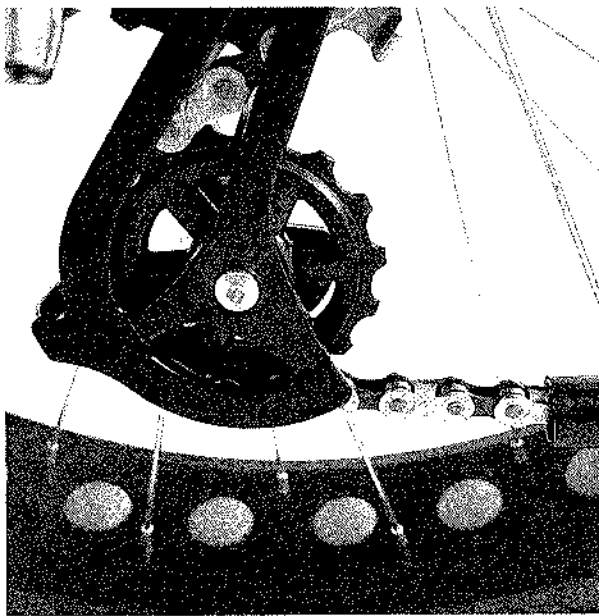
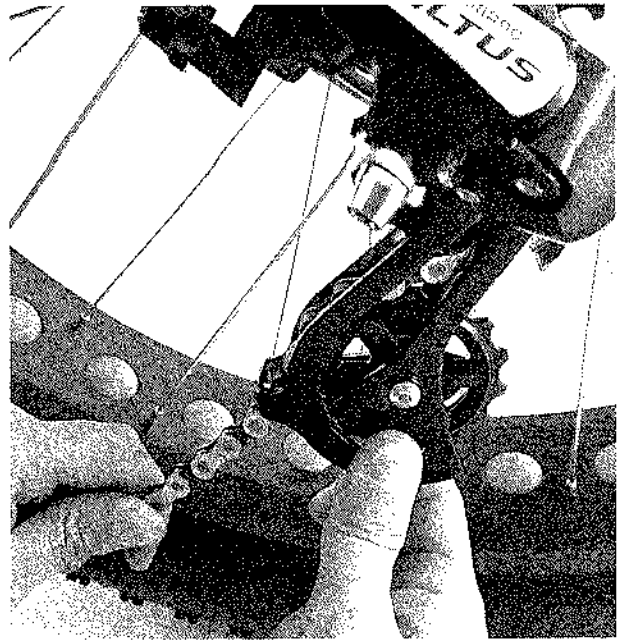
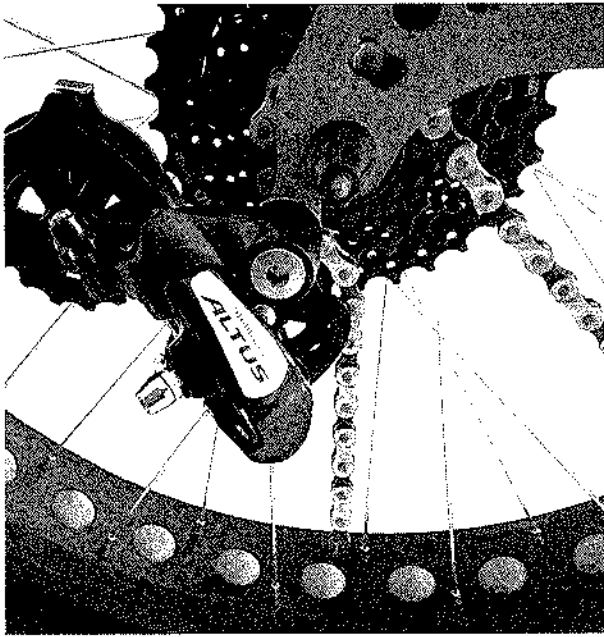

The structure of chain

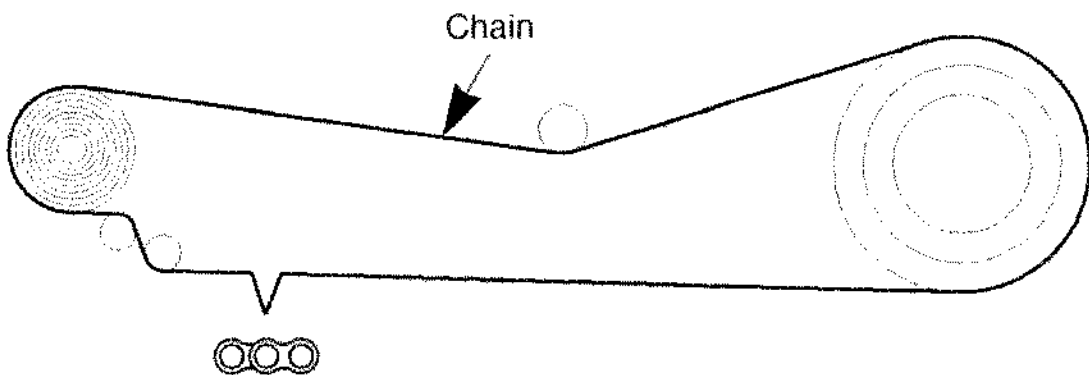

10. Assemble the brake cables

a. Remove the outer casing and put the inner wire into brake lever

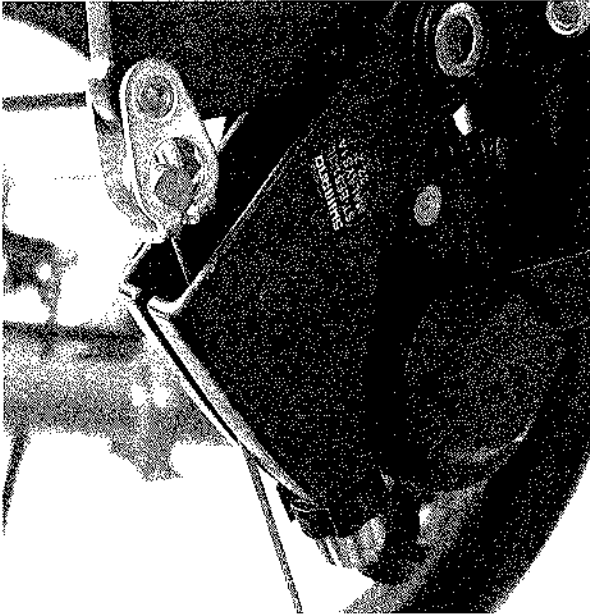

b. Thread the inner wire through brake lever tighten the screw and insert it to outer casing

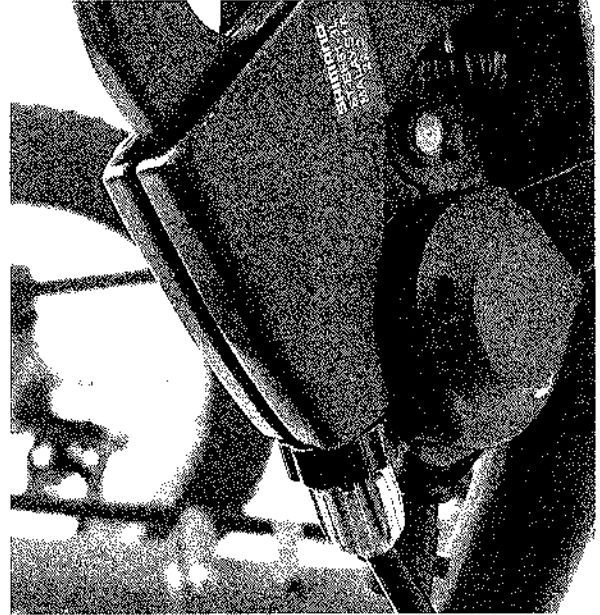

c. Thread the inner wire through the hole on the caliper

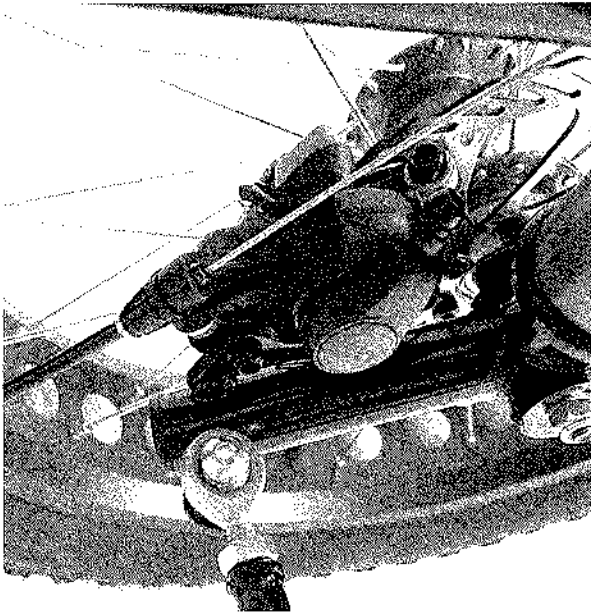

d. Tighten the screw

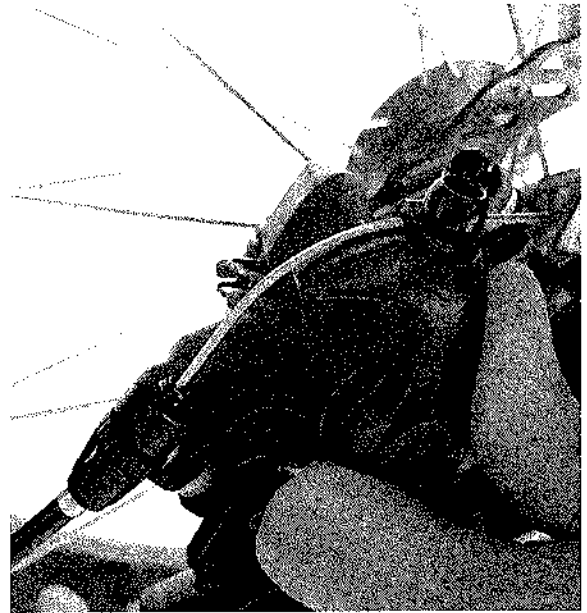

11. Assemble the front derailleur cable

Thread the front derailleur cable outer casing through the guide on the side of the frame and up towards the end of the front boom. Thread the inner wire through the outer casing and then through the cable guide tube.

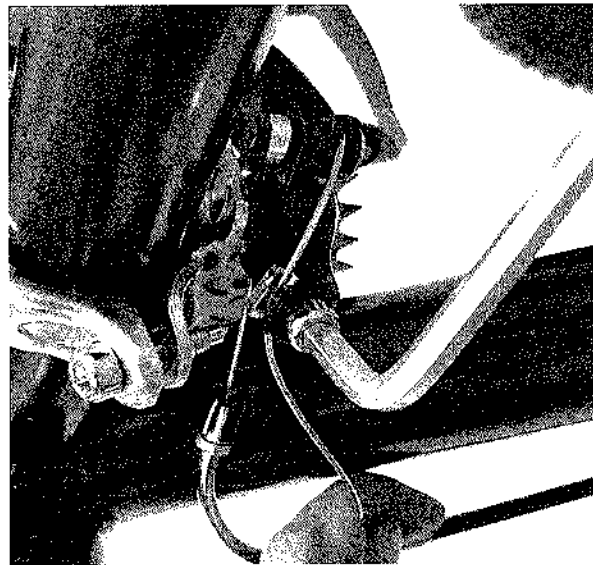
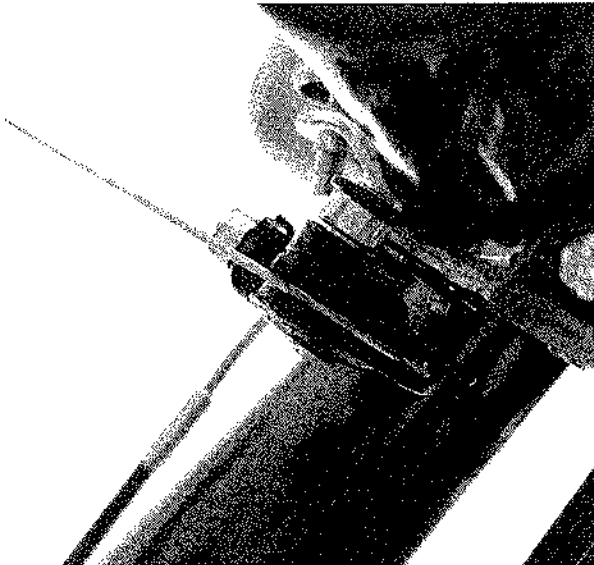
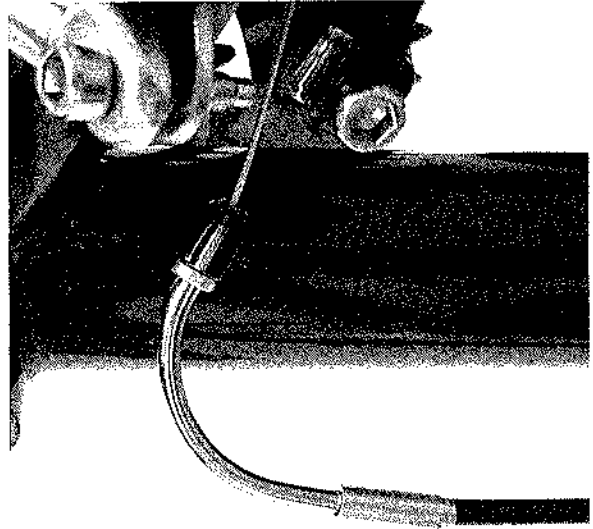
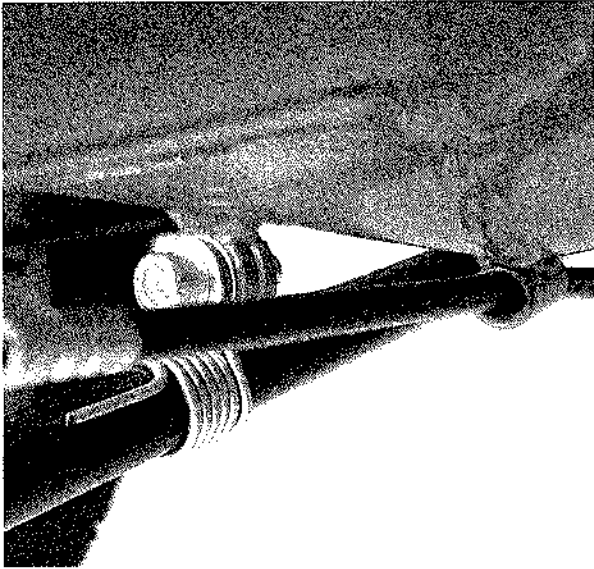

12. Assemble the rear derailleur cable

Thread the rear derailleur cable outer casing through the guide on the side of the frame and up towards the end of the front boom. Thread the inner wire through the outer casing and then through the cable guide tube.

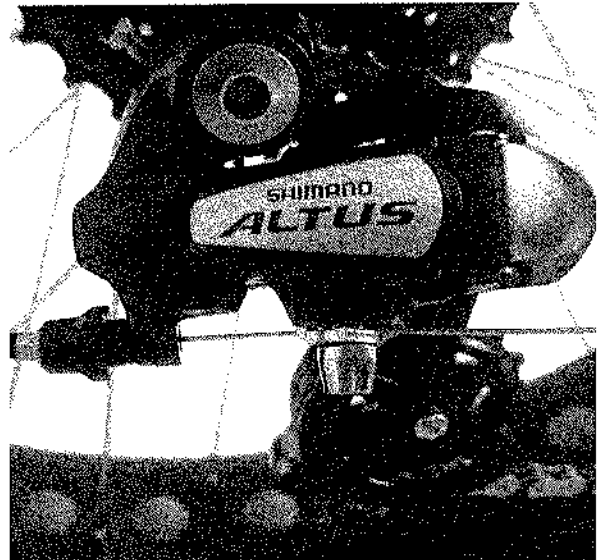
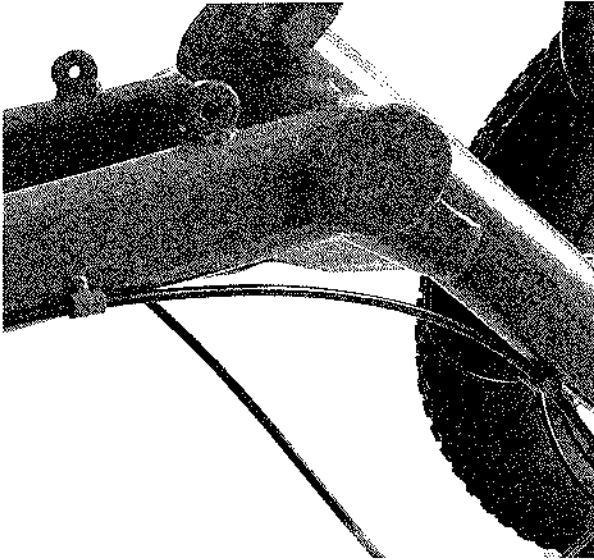

13. Assemble the seat

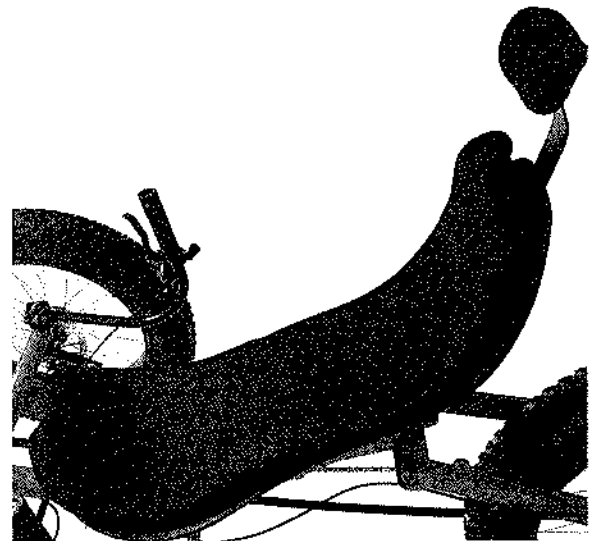
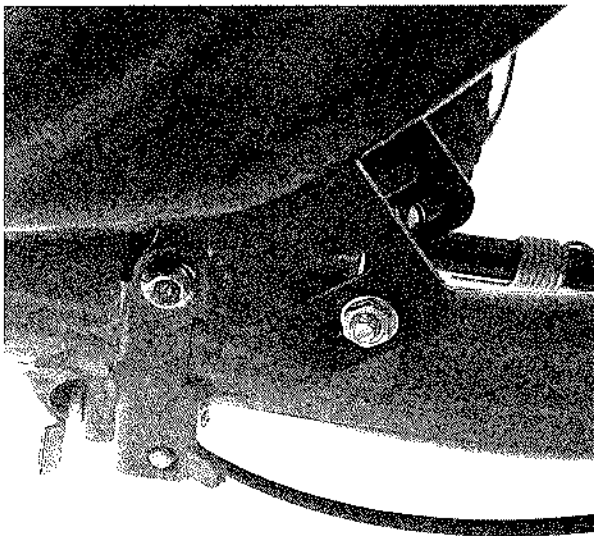

14. Assemble the pedal and mirror

Pay the attention to Left and Right pedal

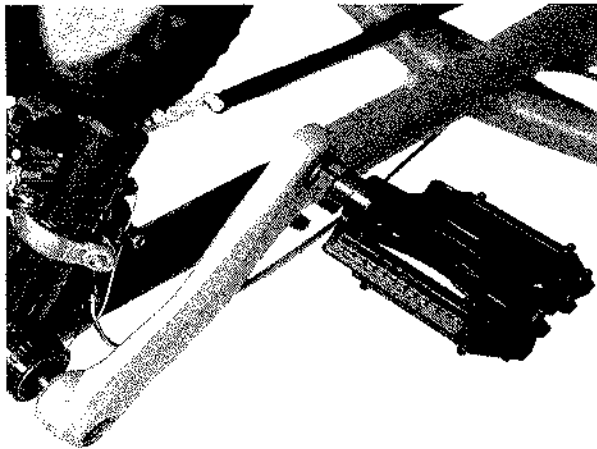

Mount the mirrors in the top of the handlebars

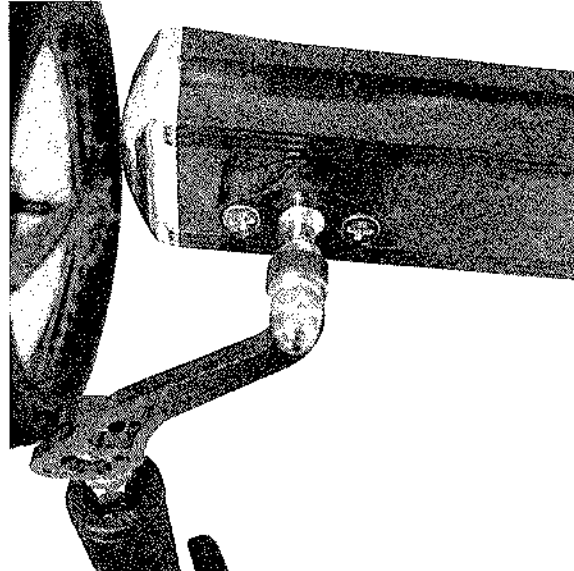

15. Mount the flagpole and put the end of cables in the production cover

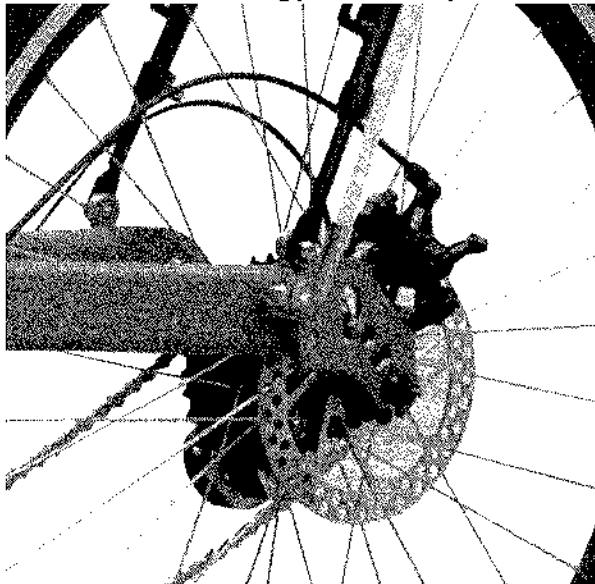

16. Finish the assembly